

**Logic Analyzer ETC M611
User's Guide
Version 1.04**

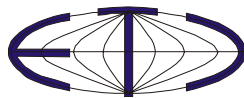

Copyright © 2003 - 2004, ETC s.r.o.

Thank you for choosing Logic Analyzer M611, a product of ETC s.r.o.. We believe it will fulfill your expectations. In order to assure that we will be able to provide you with up-to-date information, please fill-out and send us the registration form included in the Analyzer delivery package, or register using the registration form at the ETC web-site.

For any further information or consultations, please contact us via mail, phone or preferably e-mail on the following addresses:

Address:

ETC s.r.o.
Rosinská cesta 8
010 08, Žilina
Slovak Republic

Phone:

+421-41-5667894 – Sales Department
041-5667894

Fax:

+421-41-5667894
041-5667894

Internet:

URL: <http://www.etcsk.com>
E-mail support@etcsk.com – Technical Support
sales@etcsk.com – Sales Department
info@etcsk.com - General Information

Contents

Contents of the delivery	7
Warranty conditions	7
Software License Agreement	8
Precautions	8
1. Installation	9
1.1 Hardware Requirements	9
1.2 Hardware installation	9
1.2.1 Installation of the M611/I hardware to the AT type computer	9
1.2.1 Installation of the M611/E hardware	14
1.2.4 Connecting several devices	15
1.2.5 Connection to the USB port	16
1.3 Software installation	16
2. Technical description of the equipment	18
3. Basic Controls of the Analyzer	20
3.1. Connector Layout	20
3.2. Basic Terms	21
3.3. Pop-up panels and the panel list	22
3.4. Time Analysis Screen	22
3.4.1. Signal Display	25
3.4.2. Bus Display	25
3.4.3. Wave form screen pop-up menu	25
3.4.4. Cursor pop-up menu	27
3.4.5. Setting the trigger word	28
3.4.6. Net name pop-up menu	29
3.4.7. Time Analysis Screen Controls	29
3.4.8. The comparison tool	30
3.5. State Analysis Screen	31
3.5.1. State Analysis Screen Pop-up Menu	32
3.5.2. Name Display	33
3.5.3. Setting the trigger word	34
4. Analyzer Controls	35
4.1. Main Menu	35
4.1.1. Saving and Loading the data	35
4.1.2. Net Configuration	35
4.1.3. Communication Settings	37
4.2. Setting the analyzer time base	37
4.2.1. Internal clocking source	38
4.2.2. External clocking source	38
4.3. Trigger control panel	39
4.3.1. Trigger controls	39
4.3.2. Measurement cycle controls	40
4.4. Probe settings controls	41
4.4.1. EA111 probe controls	42
4.4.2. EA112 probe controls	42
4.4.3. EA113 probe controls	42
4.5. Print Support	43
4.5.1. Setting the name of a new layout	45

4.5.2. Layout Manager	45
5. Technical Specifications	47
5.1. M611 Analyzer Technical Specifications	47
5.1.1. Timing Analysis	47
5.1.2. State Analysis	47
5.2. EA111 Probe Technical Specifications.....	47
5.3. EA112 Probe Technical Specifications.....	48
5.4. EA113 Probe Technical Specifications.....	48
6. Programmer's information	49
6.1. .dw format description.....	49
6.1.1. Data structures.....	49
6.1.2. Description	49
6.1.3. Time base codes	50
6.1.4. Probe reference voltages	51
6.1.5. Probe codes	51

Figures

Fig.1.2.1.1: The jumpers layout	10
Table 1.2.1.2: Recommended jumper switch settings.....	10
Fig.1.2.1.3: Analyzer Connectors.....	11
Fig. 1.2.2.1.: Jumpers layout	12
Table 1.2.2.2: Recommended jumper switch settings.....	12
Fig.1.2.2.3: Rear panel of the computer case with analyzer installed.....	14
Fig. 1.2.3.1: Layout of the Analyzer back panel	14
Fig. 1.2.4.1 Installation of two devices	15
Fig. 1.2.4.2 Installation of three devices	16
Fig.1.2.5.1: How to connect the USB adapter.....	16
Fig. 2.1: Block scheme of the analyzer	18
Fig. 3.1.1: Front panel of the device	20
Fig. 3.1.2: Bottom part of the device.....	20
Fig. 3.3.1: Workspace - panels “Trigger” and “Time base” open.....	22
Fig. 3.4.1: Time Analysis Screen	23
Fig. 3.4.2: Information on the period defined by the cursors.....	24
Fig. 3.4.3: Arrow representing a cursor not visible on the screen.....	24
Fig. 3.4.4: Net names	24
Fig. 3.4.5: Assignment of the physical signals to the net signals.....	25
Fig. 3.4.1.1: Signal Display.....	25
Fig. 3.4.1.2: Bus Display.....	25
Fig. 3.4.3.1: Wave form screen pop-up menu.....	26
Fig. 3.4.3.2: Cursor Submenu	26
Fig. 3.4.3.3: Bus value type submenu	27
Fig. 3.4.3.4: Row height submenu	27
Fig. 3.4.3.5.: Tools submenu.....	27
Fig. 3.4.4.1: Cursor pop-up menu	27
Fig. 3.4.5.1: Trigger word display.....	28
Fig. 3.4.5.2: Bus trigger word window	29
Fig. 3.4.6.1: Net name pop-up menu.....	29
Fig. 3.4.7.1: Time Analysis Screen Controls	30
3.4.8.1. – Comparison tool configuration.....	30
Fig. 3.5.1: State Analysis Screen.....	31
Fig. 3.5.1.1: State Analysis Screen Pop-up Menu.....	32
Fig. 3.5.1.2: Jump to base window.....	32
Fig. 3.5.1.3: Jump to bookmark submenu	32
Fig. 3.5.1.4: Add bookmark submenu	33
Fig. 3.5.1.5: Bookmark name dialog box.....	33
Fig. 3.5.1.6: Remove bookmark submenu	33
Fig. 3.5.1.7: Column width submenu	33
Fig. 3.5.3.1: Trigger words shown on the state analysis screen.....	34
Fig. 4.1.2.1: Configure nets window	36
Fig. 4.1.3.1: Communication settings window.....	37
Fig. 4.2.1: Clock source settings	37
Fig. 4.2.1.1: Time base with internal clocking source	38
Fig. 4.2.2.1: Time base with the external source of the clocking impulses	38
Fig. 4.3.1: Trigger controls.....	39

Fig. 4.3.1.1: The part of the Trigger panel with trigger controls	39
Fig. 4.3.1.2: External trigger source.....	40
Fig. 4.3.1.3: Internal trigger source.....	40
Fig. 4.3.1.4: Trigger and sample gathering settings control.....	40
Fig. 4.3.2.1: Measurement cycle controls	41
Fig. 4.1.1: Probe settings controls	41
Fig. 4.4.1.1: EA111 probe controls	42
Fig. 4.4.2.1.: EA112 probe controls	42
Fig. 4.4.3.1.: EA113 probe controls	42
Fig. 4.5.1: Print Manager Window.....	43
Fig. 4.5.2: Object Info	44
Fig. 4.5.3: List of available objects	44
Fig. 4.5.1.1: Specify Layout Name Window.....	45
Fig. 4.5.2.1: Layout Manager Window	46
Table 5.1.1.1. – M611 analyzer technical specifications in timing analysis mode	47
Table 5.1.2.1. – M611 analyzer technical specifications in state analysis mode	47
Table 5.2.1. – EA111 technical specifications	47
Table 5.3.1. – EA112 technical specifications	48
Table 5.4.1. – EA113 technical specifications	48
Table 6.1.1.2. – Format .dw data structures	49
Table 6.1.3.1. – Time base codes	51
Table 6.1.4.1. – Probe reference voltages	51
Table 6.1.5.1. – Probe codes	51

Contents of the delivery

M611/I

- Analyzer M611/I module – 1pc
- Connection cable for AT cased PC (EA600) – 1pc
- Extension cable for printer connector (EA601) – 1pc
- Cable for ATX cased PC (EA602) – 1pc
- Bracket with parallel port connector and cable (EA603) – 1pc
- M3 mounting screws – 4pcs
- Measuring probe (EA611) – 4pcs
- Set of measuring hooks (EA327/8S) – 4pcs
- This Installation Guide – 1pc
- CD-ROM with software and User's Guide in electronic form – 1pc

M611/E

- Analyzer M611/E module – 1pc
- Cable for PC parallel port – 1pc
- Power adapter – 1pc
- Measuring probe (EA611) – 4pcs
- Set of measuring hooks (EA327/8S) – 4pcs
- This installation Guide – 1pc
- CD-ROM with software and User's Guide in electronic form – 1pc

Warranty conditions

The ETC s.r.o. company guarantees reliable operation of the M611 analyzer in compliance with this documentation during a period of 24 months from the date of purchase.

Should a malfunction occur during the warranty period, excluding errors for which ETC can not be held responsible, ETC guarantees the repair of the product or its replacement with a new or repaired one free of charge.

The ETC company shall not be responsible for malfunctions on the device caused by an accident, incorrect manipulation, unauthorized interventions or similar.

When requesting the guaranteed service, the customer should send the device in its original package to the dealer from whom it was purchased or directly to the ETC company. The warranty certificate together with a description of the defect or malfunction should be included in the package. The customer agrees that a new or repaired product to be shipped would be insured against damage or loss during the transport and that he will cover the costs for the shipment and insurance.

Software License Agreement

This legal document is an agreement between you, the end user, and ETC s.r.o. By installing this product on your computer, you are agreeing to become bound by the terms of this agreement and warranty conditions.

1. GRANT OF LICENSE. ETC Ltd. as Licensor, grants you, the License, a nonexclusive right to use and display this copy of the M611 software (hereinafter the "SOFTWARE"), this EM611 device and accompanying written materials, on a single COMPUTER at a single location and only together so long as you comply with the terms of this License.

2. OWNERSHIP. As the LICENSEE, you own the magnetic or other physical media on which the SOFTWARE is originally or subsequently recorded or fixed, but an express condition of this License is that ETC s.r.o. retains title and ownership of the SOFTWARE recorded on the original disk copy(ies) and all subsequent copies of the software, regardless of the form or media in or on which the original and other copies may exist. This License is not a sale of the original SOFTWARE or any copy.

3. COPY RESTRICTIONS. This SOFTWARE, EM611 device and accompanying written materials are copyrighted. Unauthorized copying or copy attempt of the EM611 device, including card which has been modified or included with any other system, or of written materials is expressly forbidden. It is, however, allowed to pass SOFTWARE on as the DEMO version. You may be held legally responsible for any copyright infringement which is caused or encouraged by your failure to abide by the terms of this License.

4. DISCLAIMER OF THE WARRANTY OF ANY KIND CONCERNING SOFTWARE. This SOFTWARE and accompanying written materials are provided "AS IS" without a warranty of any kind. Further, ETC s.r.o. does not warrant, guarantee or make any representations regarding the use, or the results of use, of the SOFTWARE, EM611 device or written materials in terms of correctness, accuracy, reliability, currentness, or otherwise. The entire risk as to the results and performance of the software is assumed by you.

Precautions

Please follow these recommendations to avoid any possible problems that might occur while using the analyzer:

- Please read the User's guide carefully
- The internal module should be installed or removed only while the PC is shut down
- The external triggering and synchronization input (TI/SO) should not be connected to voltage exceeding the range of -1V to +5V
- Only the measuring probes originally delivered should be connected to the measuring probe connectors
- The input voltage limits for the measuring probes should not be exceeded

1. Installation

1.1 Hardware Requirements

The minimum hardware configuration:

- PC486 compatible
- 16MB RAM
- CD-ROM
- VGA (minimum resolution 800x600)
- EPP V1.9 or EPP + ECP parallel port (with EC602 adapter an USB port is sufficient)
- Mouse or other tracking device
- 10MB HDD free space
- MS Windows 98, ME, NT 4.0, 2000, XP

Recommended hardware configuration:

- PC PENTIUM compatible 400MHz clock frequency
- 64MB RAM
- CD-ROM
- VGA (resolution 1024x768)
- EPP V1.9 or EPP + ECP parallel port (with EC602 adapter an USB port is sufficient)
- Mouse with wheel
- 10MB HDD free space
- MS Windows 98, ME, NT 4.0, 2000, XP

1.2 Hardware installation

Prior to the installation please assure that the computer's "PRINTER PORT" is set in the EPP (or EPP+ECP) mode. If not, set this mode. (For instructions consult the BIOS documentation of your PC). If possible, choose EPP V1.9 mode.

WARNING: If the "PRINTER PORT" of your computer does not operate in the EPP (or EPP + ECP) mode, at the start-up the software will report communication error.

1.2.1 Installation of the M611/I hardware to the AT type computer

Before the installation it is necessary to check the configuration jumpers. A look at the board will show two groups of jumpers.

- Four pairs of pins marked ADDRESS determine the address of the device on the bus. The respective weights of the pairs of pins are 1, 2, 4 and 8. These weights are applied if the jumper is not attached and the jumper is open. In case the jumper is short, the value of the corresponding position is 0.

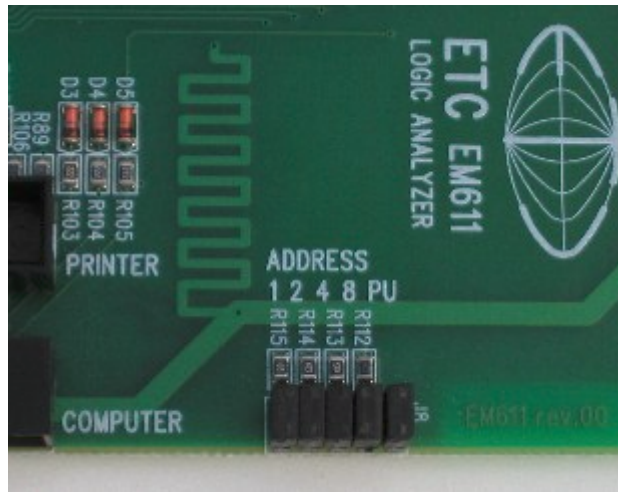

Fig.1.2.1.1: The jumpers layout

- A pair of pins marked “PU” is used to apply pull-up resistors for certain control signals which increases the communication speed. If the jumper is installed, the pull-up resistor is connected. It is recommended to set the PU jumper only if the address of the device is 0.

Address	1	2	4	8	PU
0	Short	Short	Short	Short	Short
1	Open	Short	Short	Short	Open
2	Short	Open	Short	Short	Open
3	Open	Open	Short	Short	Open
4	Short	Short	Open	Short	Open
5	Open	Short	Open	Short	Open
6	Short	Open	Open	Short	Open
7	Open	Open	Open	Short	Open
8	Short	Short	Short	Open	Open
9	Open	Short	Short	Open	Open
10	Short	Open	Short	Open	Open
11	Open	Open	Short	Open	Open
12	Short	Short	Open	Open	Open
13	Open	Short	Open	Open	Open
14	Short	Open	Open	Open	Open
15	Open	Open	Open	Open	Open

Table 1.2.1.2: Recommended jumper switch settings.

TIP: If you install the Analyzer as the only EML II device, it is not necessary to change the jumper settings.

WARNING: The address of one of the devices installed has to be set to 0.

WARNING: Two EML II devices installed in one computer may not have identical addresses.

TIP: If you change the address of a device, it is necessary to change also its address in the software settings.

The Logic Analyzer module occupies two positions of 5 ¼“ Floppy Drives. Before you begin the installation unplug the computer from the wall. Then remove the cover of the computer, remove the plastic parts covering two neighboring disk drive slots. Insert the module from the front and fix it by four screws delivered in the accessories.

WARNING: To prevent damage, do not use screws longer than 6mm.

Connect one of the floppy drive power supply cable to the power supply connector on the module. Disconnect the ribbon cable which connected the printer to the motherboard. Instead of this insert here the end of the flat cable from the accessories fixed with one connector. The end of the cable with two connectors fixed attach to the analyzer (using any of the two connectors). Make sure the edge of the ribbon cable marked with a colored stripe leads to the contact no.1 of the motherboard connector. Now insert the ribbon cable that connected the printer to the motherboard into the analyzer's connector marked "PRINTER". In case the cable is too short, use the cable extension from the accessories. This was the final step of the installation. Now you can again cover the computer case. Here is a figure to help you identify the analyzer connectors.

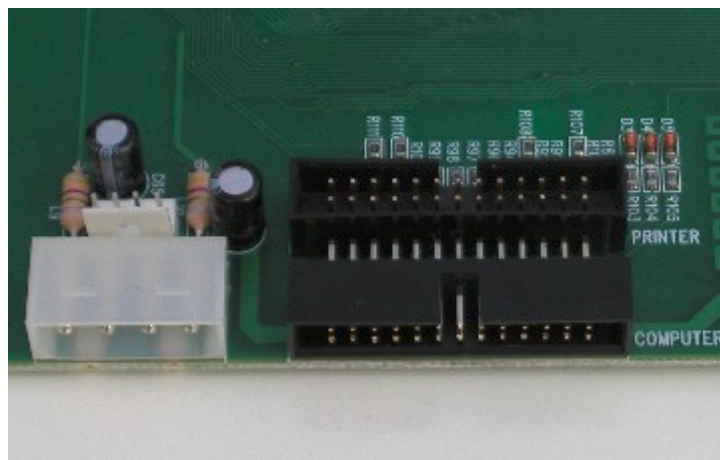

Fig.1.2.1.3: Analyzer Connectors

If there already is a device of EML II System installed in the computer the installation of the second one proceeds along the same steps. The only difference is that the preset address value 0 has to be changed. The second device should be connected to the second connector fixed on the cable of the already installed device.

WARNING: The printer has to be connected to the device with address 0, otherwise it would not function.

1.2.1 Installation of the M611/I hardware equipment to the ATX type computer

Before the installation it is necessary to check the configuration jumpers. Jumper layout can be seen on fig.1.2.2.1 A look at the circuit board will show two groups of jumpers:

- Four pairs of pins marked “ADDRESS” determine the address of the device on the bus. The respective weights of the pairs of pins are 1, 2, 4 and 8. These weights are applied if the jumper is not installed. In case the jumper is installed, the value of the corresponding position is 0.

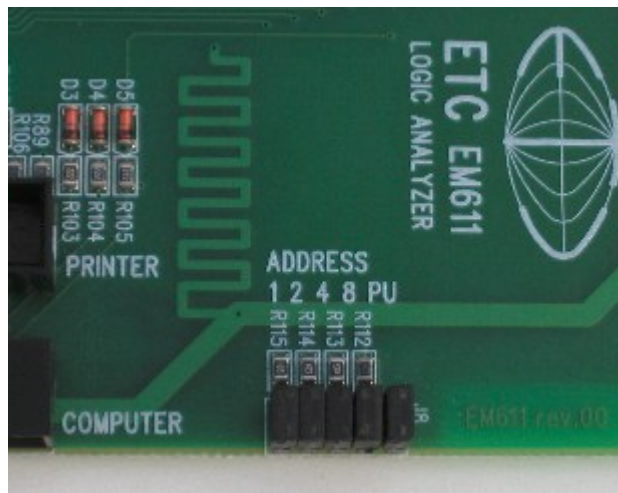

Fig. 1.2.2.1.: Jumpers layout

- A pair of pins marked “PU” is used to apply pull-up resistor for some control signals which increases the communication speed. If the jumper installed, the pull-up resistor is connected. It is recommended to install the PU jumper only if the address of the device is 0.

Address	1	2	4	8	PU
0	Short	Short	Short	Short	Short
1	Open	Short	Short	Short	Open
2	Short	Open	Short	Short	Open
3	Open	Open	Short	Short	Open
4	Short	Short	Open	Short	Open
5	Open	Short	Open	Short	Open
6	Short	Open	Open	Short	Open
7	Open	Open	Open	Short	Open
8	Short	Short	Short	Open	Open
9	Open	Short	Short	Open	Open
10	Short	Open	Short	Open	Open
11	Open	Open	Short	Open	Open
12	Short	Short	Open	Open	Open
13	Open	Short	Open	Open	Open
14	Short	Open	Open	Open	Open
15	Open	Open	Open	Open	Open

Table 1.2.2.2: Recommended jumper switch settings

TIP: If you install the Analyzer as the only EML II device, it is not necessary to change the jumper settings.

WARNING: The address of one of the devices installed has to be set to 0.

WARNING: Two EML II devices installed in one computer may not have identical addresses.

TIP: If you change the address of a device, it is necessary to change also its address in the software settings.

The Logic Analyzer module occupies two 5 $\frac{1}{4}$ Floppy drive positions. Before the installation unplug the power cord of the computer from the wall. Remove the cover of the computer case, remove the plastic parts covering two neighboring disk drive slots. Insert the module from the front and fix using four screws delivered in the accessories.

WARNING: To prevent damage, do not use screws longer than 6mm.

Connect one of the floppy drive power supply cables to the corresponding power connector on the module. If there is a printer connected to the computer, disconnect it. Remove one of the V/V position covers (preferably the one next to the printer connector). Pass the ribbon cable equipped with DP25 connector through the slot. The DP25 connector (intended for the connection to the “printer port”) should be outside the case. Fix the bracket with the connector from the accessories in place of the removed cover in a way that the ribbon cable leads through the cut-out. To put through the cable should be folded in half. The connector outside insert into to printer connector of the computer and connect the ribbon cable to the analyzer connector marked “COMPUTER” using any of the connectors on the other end of the cable. Insert the terminal of the cable fixed to the bracket mounted in place of V/V cover into the connector on the analyzer marked “PRINTER”. The printer should be linked to the connector on the bracket. Figure no. 3 shows the rear panel of the computer after the installation of the Analyzer module.



Fig.1.2.2.3: Rear panel of the computer case with analyzer installed.

WARNING: The extension slots of some computer cases do not have fine treatment of the metal edges. Please, be careful to avoid damage to the isolation of the ribbon cable.

If there already is a device of EML II System installed in the computer, first mount the second device, connect to the power supply cable and then use the second connector of the already installed ribbon cable to connect the analyzer. Before the installation change the address of the device to differ from the address of the device already installed.

WARNING: The printer has to be connected to the device with address 0, otherwise it would not function.

1.2.1 Installation of the M611/E hardware

The installation is very simple. Follow the next steps:

- Make sure the power switch of the Analyzer is in the position “OFF” (the lower position). If it is not, turn it off.

- Check the address of the Analyzer. The setting of the address has to follow these rules:

1. The address of one of the devices has to be set to 0.
2. The addresses of the devices have to differ.
3. The printer will operate only if connected to the device with address 0.

If the device is connected via USB using the EC602 adapter, connect the printer directly to the computer.

4. The DIL switches should be set ON only on the device with address 0.

- Connect the device to the power adapter
- Connect the Analyzer to the EPP computer port using the cable from the accessories.

- If required, connect the printer using a standard cable (not in the accessories)
- Turn the device ON using the power switch.

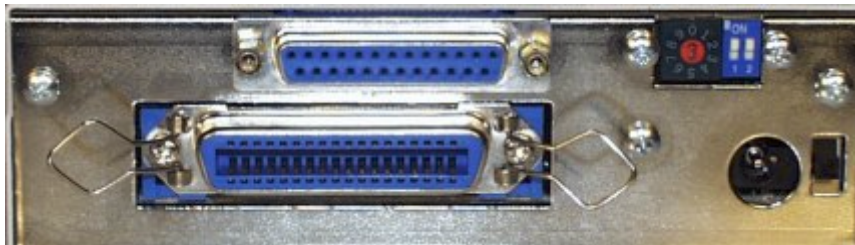
*Fig. 1.2.3.1: Layout of the Analyzer back panel*

WARNING: Connect the device to the computer using only cable from the accessories. With improper cable some communication errors may occur.

1.2.4 Connecting several devices

To connect more than one device to the computer following guidelines should be applied:

- The addresses of the devices of the EML II system must differ
- One of the devices has to have its address set to 0
- The printer should be connected to the device with address set to 0
- It is convenient to place the devices on top of each other
- To connect two external devices EA604/2 adapter should be used (see Fig. 1.2.4.1.)
- M621/E oscilloscope does not enable to change its address without removing its cover. Therefore it is recommended to use the preset address value 0. To provide easy access to the printer connector it is convenient to place it as the uppermost device.

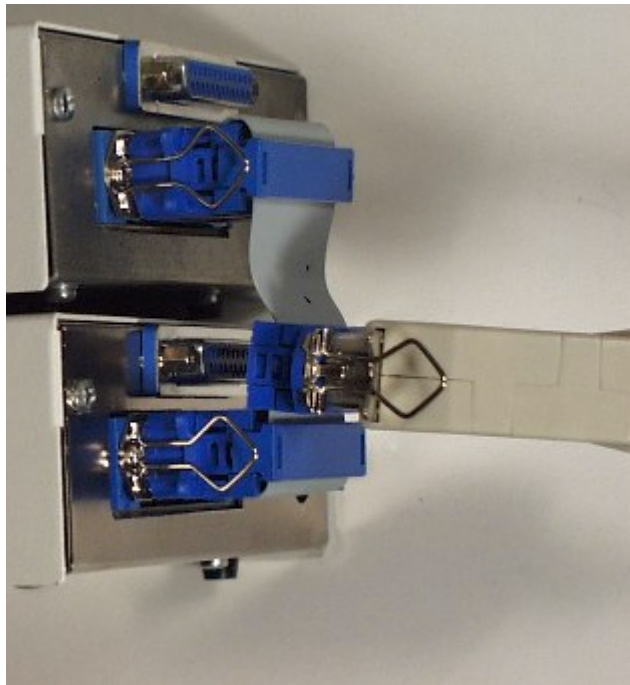

Fig. 1.2.4.1 Installation of two devices

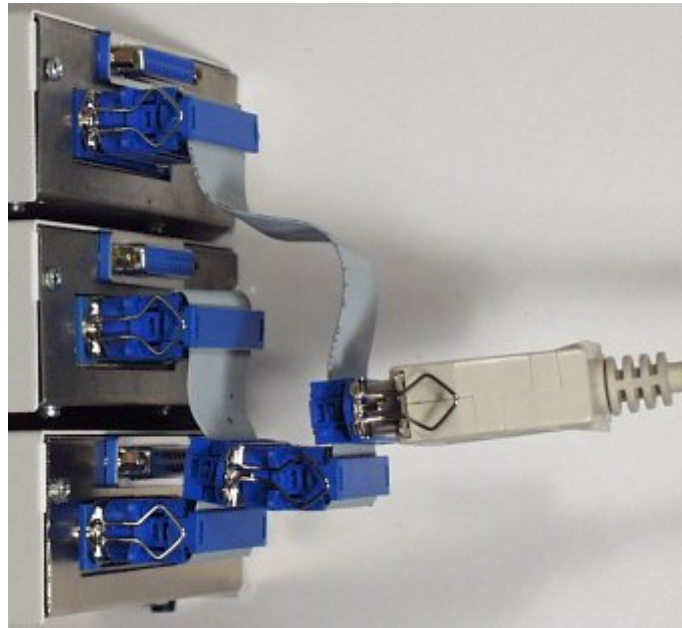

Fig. 1.2.4.2 Installation of three devices

1.2.5 Connection to the USB port

It is possible to connect the EML devices to the computer via the USB interface using ETC EC602 adapter (not included in the standard delivery). One adapter allows to connect up to 15 devices. The installation is very simple. Connect the terminal of the USB cable to the adapter and instead of the parallel port cable connect the device (or reduction for multiple devices) using the connector fixed at the end of the short cable of EC602 adapter. The other end of the USB cable insert into any of the plugs of the computer's USB interface. This is the final step of the hardware installation. If the devices are connected to the USB port, connect the printer directly to the computer.



Fig.1.2.5.1: How to connect the USB adapter

1.3 Software installation

The software and the device drivers are located on the enclosed CD. Insert the CD into the CD-ROM drive. Then follow the instructions of the setup program that

should launch automatically. If the CD autorun is not enabled in your computer's settings, please run file autorun.exe from the CD.

2. Technical description of the equipment

The block scheme of the M611 Analyzer is shown in the figure 2.1. It is possible to connect up to four 8bit probes to the analyzer's inputs. The output data from these probes (P1D to P4D) are connected to input of buffer IB. The outputs of this buffer drive the inputs of the fast memory (M) and inputs of the comparator (CMP) which detects the trigger word of the analyzer. The comparator compares the data DI with a 32bit reference word (REF), while another 32bit word (INH) determines which bits are to be compared and which are not. Using the information from the comparator the CNT segment controls the data acquisition, generating control signals for the input buffer IB, address and control signals for the memory M.

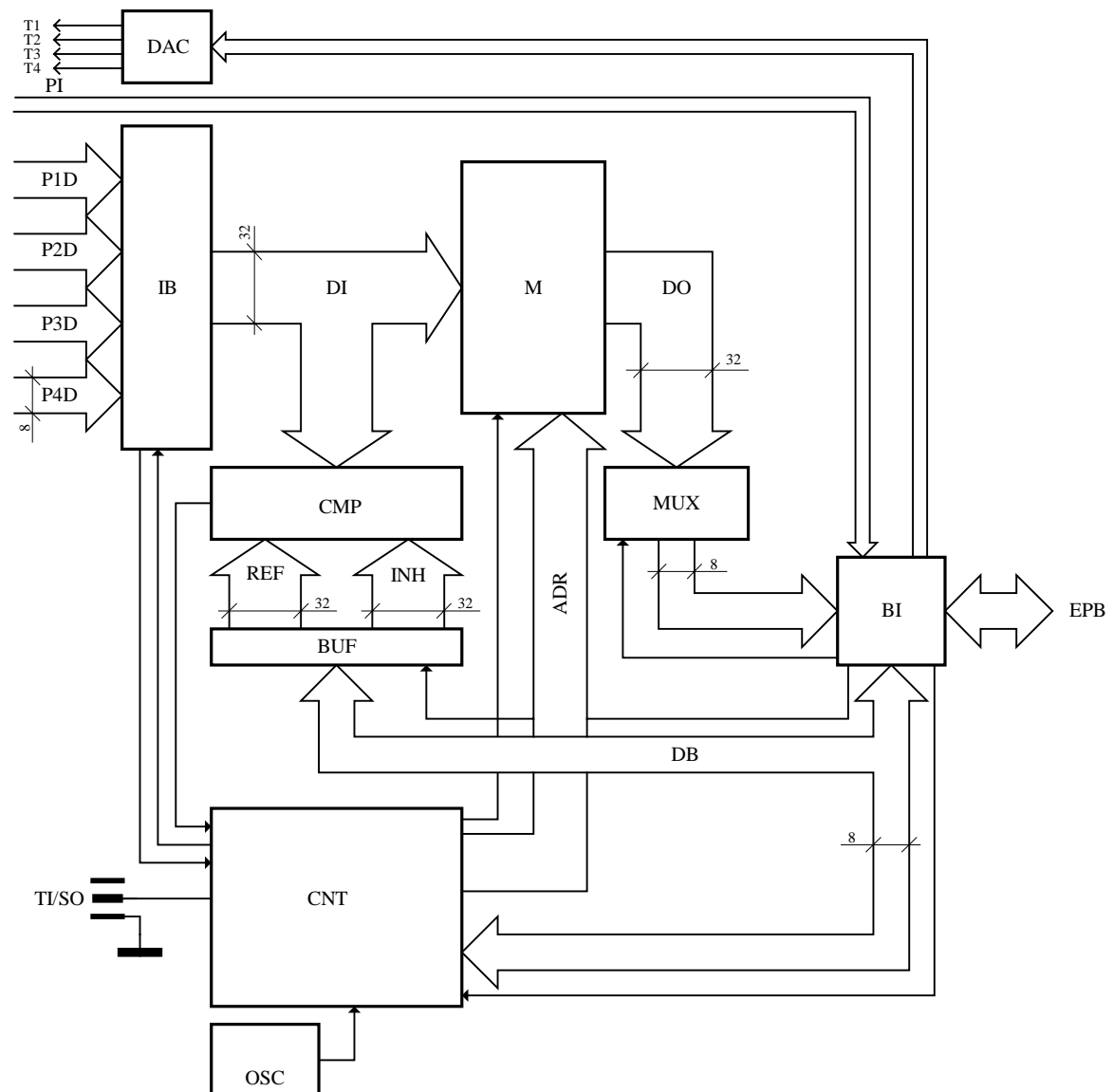

Fig. 2.1: Block scheme of the analyzer

The analyzer operates in two basic modes:

- Timing analysis mode. In this mode the data acquisition is clocked by crystal controlled oscillator (OSC), used as software controllable time base generator.
- State analysis mode. Here the data acquisition is clocked by one of the outputs of the measuring probe (7th bit of the 4th probe). This bit can be masked by another output (Arm) (6th bit of the 4th probe)

It is also possible to use an external triggering input (TI/SO) instead of the comparator. When this input is not used for triggering, it is possible to connect it to the output signal of comparator CMP, which allows synchronizing analyzer with another device (e.g. oscilloscope).

The analyzers should be connected to the EPP port of the computer. The communication runs under the "ETC PRINTER BUS" protocol (EPB) which enables to connect up to 15 devices to a single EPP port. The communication with the computer is provided by the BI segment, which also communicates with the other segments of the analyzer. The communication with the computer is byte-oriented and therefore a multiplexor (MUX) is employed to change the width of data when reading the data and an 8bit-buffer to write the reference information for the comparator.

The probes also provide the analyzer with identification information (PI). Using this information the analyzer software can display information on the type of the probe and show a control panel for each particular probe on the workspace. The hardware of the analyzer allows setting the output of the digital/analog converter for each probe (T1 to T4). This makes possible to control a certain parameter of the probe, most often its threshold voltage.

3. Basic Controls of the Analyzer

3.1. Connector Layout

The following connectors and controls are located on the front panel of the analyzer: Probe no.1 and no.2 Connectors, Synchronization Input/Output and a signal LED diode.

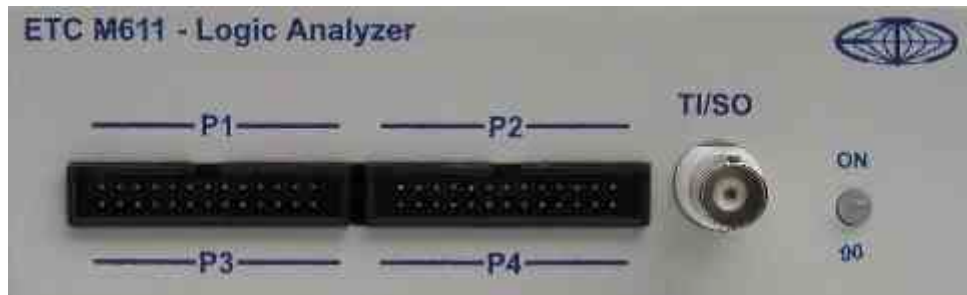

Fig. 3.1.1: Front panel of the device

The Probe no.1 should be connected to the P1 Connector.

The Probe no.2 should be connected to the P2 Connector.

The synchronization input/output should be connected to the TI/SO connector.

Green LED shows that the device is turned ON and at the moment does not communicate with the computer. If the LED goes orange, it shows that the device is operating and at the moment communicating with the computer.

The Probe no.3 and no.4 Connectors are found on the bottom part of the device. The location of the connectors is indicated by captions in the lower part of the front panel.



Fig. 3.1.2: Bottom part of the device

The Probe no. 3 should be connected to the connector on the left (see figure 3.1.2). Corresponding caption on the front panel is P3. The Probe no. 4 should be connected to the connector on the right. Corresponding caption on the front panel is P4.

When operating in the State Analysis Mode it is necessary to connect the clock pulses to the 7th pin of the Probe no.4 and the “arm” signal to the 6th pin of the Probe no.4. (See [Chapter 4.2](#))

3.2. Basic Terms

This Chapter explains the basic terms used throughout the text.

Click – Position the mouse pointer over the chosen object. Then press and release the left mouse button.

Double-Click – Two successive clicks.

Drag – Position the mouse pointer over the object you want to move. Then press the left mouse button and hold it down. The chosen object moves with the mouse pointer. After releasing the mouse button the object moves to the new location.

Enter the value into the edit box – Click the edit box. Use the keyboard to enter the desired value and confirm pressing “Enter”.

Insert the value into the edit box – Click the edit box. Use the keyboard to enter the desired value.

Set the value using the scroll bar – It is possible to change a value by simply dragging the scroll bar slider. Clicking the arrows of the scroll bar increases or decreases the value by minimal steps. Clicking in between the slider and the arrows changes the value by larger steps.

Select the value from the combo box – Open the list of all the possible values of the edit box by clicking it. Then set the desired value by clicking it.

3.3. Pop-up panels and the panel list

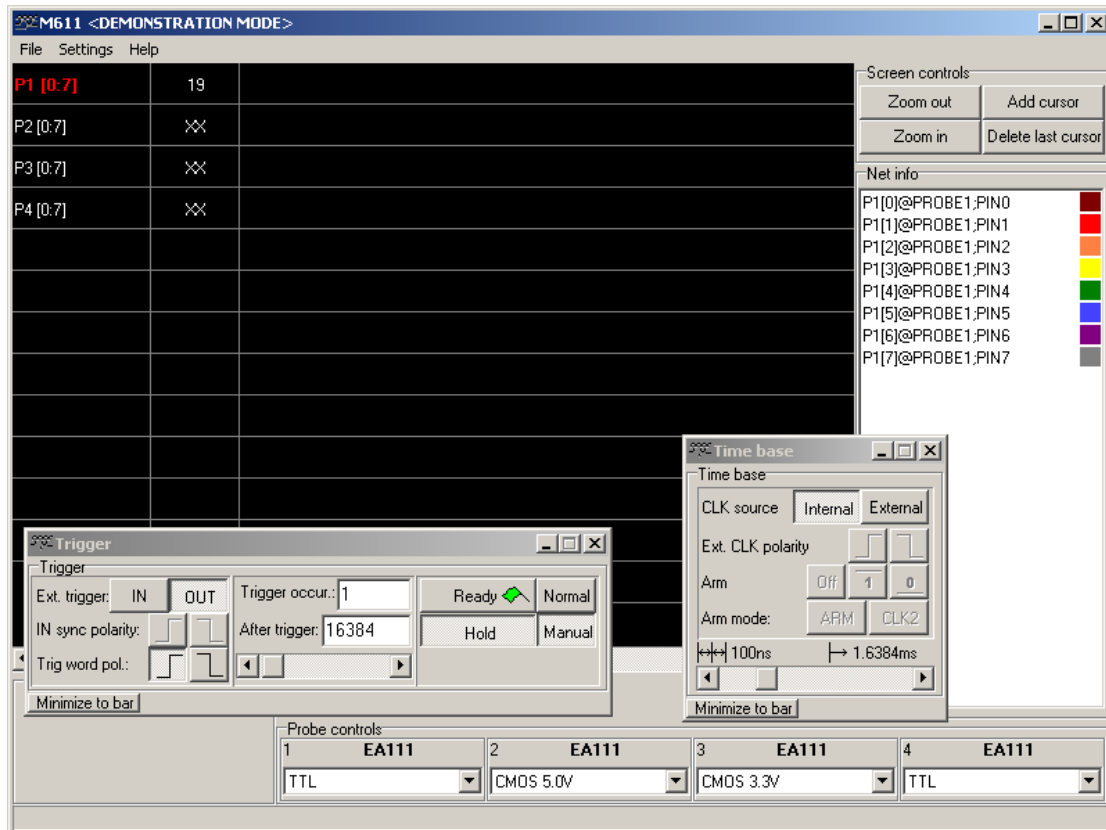

Fig. 3.3.1: Workspace - panels “Trigger” and “Time base” open

The main window of the analyzer consists of several panels. Double-click the title bar of the panel to expand it out of the main window workspace. A new window will appear containing the chosen panel and a “Minimize to bar” button. You can hide the panel into the list of panels in the bottom of the main window by clicking the “Minimize to bar” button. To restore the panel window click its title in the list. If you close the pop-up window, the panel will again appear at its original position in the main window.

3.4. Time Analysis Screen

The Time Analysis screen displays the data measured using the internal clock source.

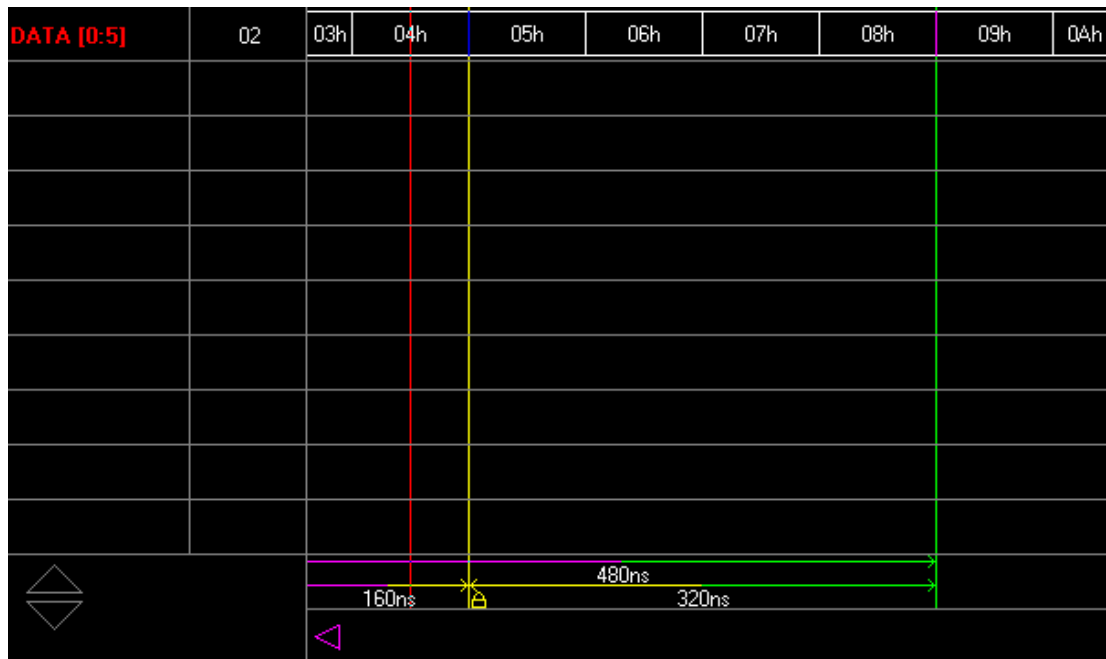

Fig. 3.4.1: Time Analysis Screen

The data of the individual nets is separated by horizontal lines. It is displayed in so-called “rows”. The way the data is displayed depends on the chosen amount of data and on the net type (signal – see [Chapter 3.4.1](#) or bus – see [Chapter 3.4.2](#))

TIP: If you want to move net in time, you can set its offset by holding “Shift” and dragging net.

WARNING: Since the time relation of the net changes by setting its offset, the background of such net is red.

The area on the right (wave form screen) displays the net data. On the left the names of the respective nets are shown. Between these two areas the trigger word is displayed. You can drag the wave form screen to change the displayed section of the data (display data from the beginning or from the end of the data area). Another way to change the displayed section of the data is to drag the scroll bar slider beneath the display area.

It is also possible to change the amount of the data displayed in the wave form screen. (See [Chapter 3.4.7](#) and [Chapter 3.4.3](#))

If you right-click the wave form screen a [wave form screen pop-up menu](#) will appear. Among other actions, this menu allows to add a new cursor. If you right-click a cursor, a [cursor pop-up menu](#) will appear. This menu allows changing the properties of the cursor. You can move the cursor by dragging it. In case more than one cursor is active, information on the period delimited by the cursors is shown in the bottom part of the screen.



Fig. 3.4.2: Information on the period defined by the cursors

TIP: Only the periods between two neighboring cursors are shown automatically. To measure the period between two non-neighboring cursors hold the CTRL key and drag one of the cursors over another. The period between these two cursors will be shown.

When the cursor is outside of the screen, an arrow of the respective color of the cursor appears in the bottom part of the screen.



Fig. 3.4.3: Arrow representing a cursor not visible on the screen

Dragging this arrow into the wave form screen will move the cursor onto the chosen position. In case the cursor is [locked](#), the arrow will appear marked with a cross.

TIP: Double-click the arrow representing the cursor that is outside of the screen to show the data in the proximity of the cursor.

There is a trigger word assigned to each of the nets. (See [Chapter 3.4.5](#)) On the left side the net names are listed.

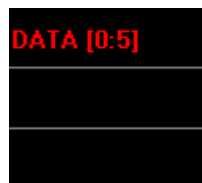

Fig. 3.4.4: Net names

If the type of the net is “signal”, its name is displayed. If the net type is “bus” its name and also size (in square brackets) is displayed. (For example the notation “0:5” indicates that the size of the bus is 6 signals).

If you right-click the net name, [net name pop-up menu](#) will appear.

To select a net, click its name. A list of the physical signals assigned to the net signals will be shown on the right side.

TIP: Double-clicking the net name has the same effect as the “Explode/Implode” item of the [net name pop-up menu](#).

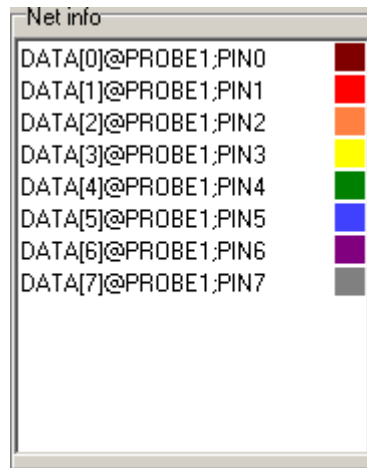

Fig. 3.4.5: Assignment of the physical signals to the net signals

3.4.1. Signal Display

The signal variable has two possible values: “0” or “1”. The null value is displayed on the screen as a line in the lower part of the row. If the value corresponding to the point on the x-axis is 1, it is displayed as a line in the upper part of the row.

In case the amount of the displayed data has been changed, it is possible, that more than one measured value would correspond to one point of the x-axis on the screen. If so, in case all the corresponding values would be identical, they would be displayed as one value. In case they would differ they would be displayed on the screen as one vertical line linking values 0 and 1.



Fig. 3.4.1.1: Signal Display

3.4.2. Bus Display

The bus is displayed as two horizontal lines. Changes of values are displayed as vertical lines. If there is enough space, the value of the bus is shown in between the lines.

TIP: To obtain a value of the bus not displayed, point the mouse over the desired part of the bus.

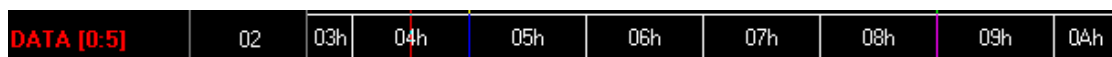

Fig. 3.4.1.2: Bus Display

3.4.3. Wave form screen pop-up menu

If you right-click the wave form screen of the time analysis screen a wave form screen pop-up menu will appear.

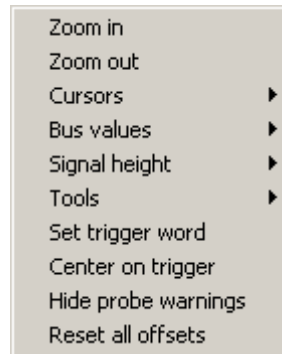

Fig. 3.4.3.1: Wave form screen pop-up menu

Following are the functions of the menu items:

“Zoom in” – Reduces the amount of the data displayed

“Zoom out” – Increases the amount of the data displayed

“Set trigger word” – Sets trigger word to the value of the net under the mouse pointer.

“Hide probe warnings” – In case some of the signal data was obtained from an input with no probe connected a warning will appear over the net display. To remove the warning, click this item. After running a new data gathering this message will appear again.

WARNING: If the warnings are hidden for some nets, these nets may contain incorrect signals.

“Reset all offsets” – Sets offset of all nets to zero (resets any offset changes, made as described in [chapter 3.4.](#))

The menu item “Cursors” contains a submenu:

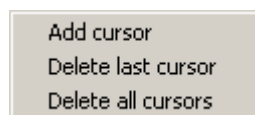

Fig. 3.4.3.2: Cursor Submenu

Following are the functions of the submenu items:

“Add cursor” – Adds a cursor on the right-clicked position.

“Delete last cursor” – Deletes the last cursor added.

“Delete all cursors” – Deletes all cursors.

TIP: It is recommended to delete the cursors using the [cursor pop-up menu](#) rather than using the menu item „Delete last cursor“.

The menu item “Bus values” contains a submenu:

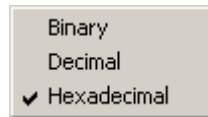

Fig. 3.4.3.3: Bus value type submenu

Following are the functions of the submenu items:

“Binary” – The bus values will be displayed in binary notation

“Decimal” – The bus values will be displayed in decimal notation

“Hexadecimal” – The bus values will be displayed in hexadecimal notation

The menu item “Signal height” contains a submenu:

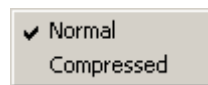

Fig. 3.4.3.4: Row height submenu

Following are the functions of the submenu items:

“Normal” – The height of the row will be normal

“Compressed” – The height of the row will be diminished

The menu item “Tools” contains a submenu:

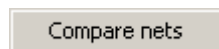

Fig. 3.4.3.5.: Tools submenu

Following are the functions of the submenu items:

“Compare nets” – Opens the window where the activation, deactivation and the configuration of the comparison tool can be changed (see [chapter 3.4.8.](#)).

3.4.4. Cursor pop-up menu

If you right-click a cursor, a cursor pop-up menu will appear.

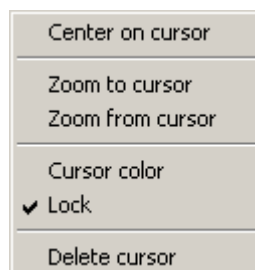

Fig. 3.4.4.1: Cursor pop-up menu

Following are the functions of the submenu items:

“Center on cursor” – Displays the data in the area around the cursor

“Zoom to cursor” – Decreases the amount of the displayed data and displays the data in the area around the cursor

“Zoom from cursor” – Increases the amount of the displayed data and displays the data in the area around the cursor

“Cursor color” – Opens a dialog window to change the color of the cursor

“Delete cursor” – Deletes the selected cursor

“Locked” – Locks or unlocks the selected cursor

TIP: When locked, a lock icon appears at the bottom end of the cursor.

3.4.5. Setting the trigger word

The trigger word is displayed between the wave form screen and the list of net names.



Fig. 3.4.5.1: Trigger word display

To change the trigger word, simply click it. The trigger word is displayed in hexadecimal notation. One character represents maximum of four signals. If the total number of signals is not divisible by 4, the upper character represents less than 4 signals. In case the signals corresponding to the character do not influence the trigger word, character X is displayed. If at least one of the signals has an influence on the word and at the same time at least one of the signals does not influence it, character Y is displayed.

WARNING: Because of the fact that triggering by an internal source is sensitive to occurrence or cessation of the trigger word, setting the trigger words of all the nets to X will prevent the triggering. If you wish to start the data gathering without defining the trigger word, select [manual mode](#).

If the corresponding net type is signal, the trigger word will change upon clicking it in a following way:

1. If the value of the trigger word was 0, it will change to 1
2. If the value of the trigger word was 1, it will change to X
3. If the value of the trigger word was X, it will change to 0

If the corresponding net type is bus, upon clicking it a window will appear which allows changing the trigger word of the net.

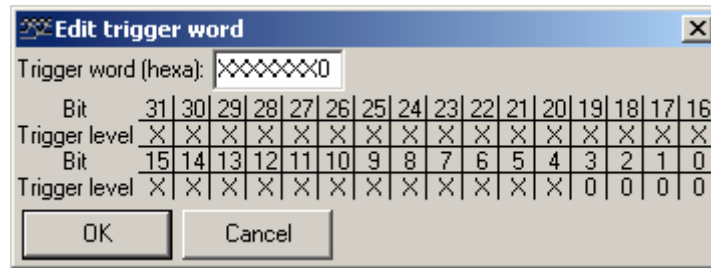

Fig. 3.4.5.2: Bus trigger word window

Entering a value into the “Trigger word (hexa)” box will change the trigger word. It is possible to change a particular signal (bit) of the net trigger word by clicking on the respective item. Such change of a particular signal will also affect the value in the “Trigger word (hexa)” box.

TIP: It is also possible to change the value of the trigger word directly from the time analysis screen. Double-clicking the bus name will decompose the bus into individual signals. Then it is possible to change the values of each individual signal. To return the bus display to its original appearance, double-click any of the signal names.

3.4.6. Net name pop-up menu

If you right-click the net name a net name pop-up menu will appear.

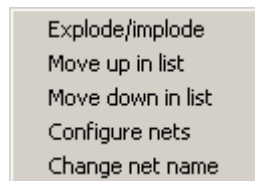

Fig. 3.4.6.1: Net name pop-up menu

Following are the functions of the menu items:

“Explode/Implode” – If the net type is bus, it will be decomposed to individual signals. If the chosen net is an individual signal of a decomposed bus, the bus will be recomposed.

“Move up in list” – Moves the net row one step up.

“Move down in list” – Moves the net row one step down.

“Configure nets” – Opens the net configuration window (See [Chapter 4.1.2](#))

“Change net name” – Opens the window, which allows change of net name

3.4.7. Time Analysis Screen Controls

The screen controls are located on the right side of the time analysis screen.

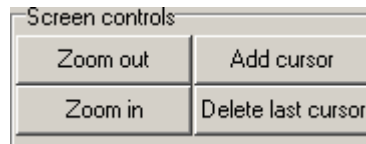

Fig. 3.4.7.1: Time Analysis Screen Controls

To increase the amount of data displayed click the “Zoom out” button.

To decrease the amount of data displayed click the “Zoom in” button.

To add a cursor, click the “Add cursor” button.

To delete the cursor added most recently, click the “Delete last cursor” button.

TIP: If the mouse pointer is over the wave form screen area, turning the mouse wheel will change the amount of data displayed. Turning forward will decrease the amount and turning backwards will increase the data amount.

TIP: It is recommended to delete the cursors using the [cursor pop-up menu](#) rather than using the menu item „Delete last cursor“.

3.4.8. The comparison tool

After activation of this tool, the parts of net, where the net is same as other selected are green and where the net differs are red.

After clicking on item of [waveform screen popup menu](#) following screen is displayed:

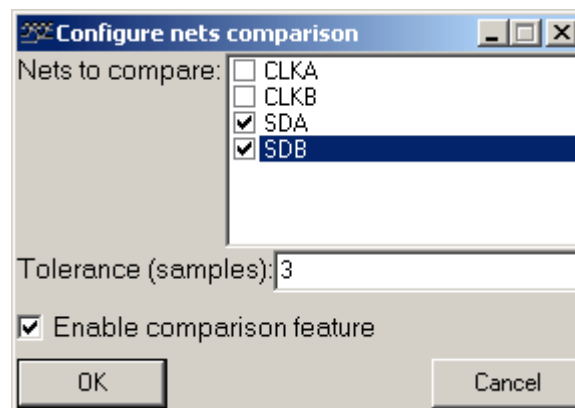

3.4.8.1. – Comparison tool configuration

The tool is activated/deactivated after click on “Enable comparison feature” checkbox.

“Tolerance (samples)” edit box contains tolerance used in comparison. If we, for example, compare net SDA with net SDB, the x-th sample is considered same, if the x-th sample of SDA is same as any SDB sample in range of x-tolerance to x+tolerance or x-th sample of SDB is same as any SDA sample in range of x-tolerance to x+tolerance.

The signals checked in “Nets to compare” will be compared.

3.5. State Analysis Screen

The state analysis screen displays the data measured using an external clocking device.

	P7	P6	P5	P4	P3	P2	P1	P0	P7	P6	P5	P4	P3	P2	P1	P0	P7	P6	P5	P4	P3	P2	P1	P0	P7
Base\Trg	0	0	0	1	1	0	0	1	X	X	X	X	X	X	X	X	X	X	X	X	X	X	X	X	
+00000	T	0	0	0	1	1	0	0	1	1	0	1	0	0	0	1	1	0	0	0	0	1	0	1	PW
+00001		0	0	0	1	1	0	0	1	1	0	1	0	0	0	1	1	0	0	0	0	1	0	1	PW
+00002		0	0	0	1	1	0	0	1	1	0	1	0	0	0	1	1	0	0	0	0	1	0	1	PW
+00003		0	0	0	1	1	0	0	1	1	0	1	0	0	0	1	1	0	0	0	0	1	0	1	PW
+00004		0	0	0	1	1	0	1	0	1	0	1	0	0	0	1	1	0	0	0	0	1	0	1	PW
+00005		0	0	0	1	1	0	1	0	1	0	1	0	0	0	1	1	0	0	0	0	1	0	1	PW
+00006		0	0	0	1	1	0	1	0	1	0	1	0	0	0	1	1	0	0	0	0	1	0	1	PW
+00007	0	0	0	0	1	1	0	1	0	1	0	1	0	0	0	1	1	0	0	0	0	1	0	1	PW
+00008		0	0	0	1	1	0	1	0	1	0	1	0	0	0	1	1	0	0	0	0	1	0	1	PW
+00009		0	0	0	1	1	0	1	0	1	0	1	0	0	0	1	1	0	0	0	0	1	0	1	PW
+0000A		0	0	0	1	1	0	1	0	1	0	1	0	0	0	1	1	0	0	0	0	1	0	1	PW
+0000B		0	0	0	1	1	0	1	0	1	0	1	0	0	0	1	1	0	0	0	0	1	0	1	PW
+0000C		0	0	0	1	1	0	1	0	1	0	1	0	0	0	1	1	0	0	0	0	1	0	1	PW
+0000D		0	0	0	1	1	0	1	0	1	0	1	0	0	0	1	1	0	0	0	0	1	0	1	PW
+0000E		0	0	0	1	1	0	1	1	1	0	1	0	0	0	1	1	0	0	0	0	1	0	1	PW
+0000F		0	0	0	1	1	0	1	1	1	0	1	0	0	0	1	1	0	0	0	0	1	0	1	PW
+00010		0	0	0	1	1	0	1	1	1	0	1	0	0	0	1	1	0	0	0	0	1	0	1	PW
+00011		0	0	0	1	1	0	1	1	1	0	1	0	0	0	1	1	0	0	0	0	1	0	1	PW
+00012		0	0	0	1	1	0	1	1	1	0	1	0	0	0	1	1	0	0	0	0	1	0	1	PW
+00013		0	0	0	1	1	0	1	1	1	0	1	0	0	0	1	1	0	0	0	0	1	0	1	PW

Fig. 3.5.1: State Analysis Screen

The data cells cover most of the screen (except for the rows 1, 2 and columns 1, 2). The data cells contain the measured data processed according to the [net configuration](#). Each column contains data from one net. Each data row contains one gathered word. To make the table structure more transparent, next to each data row its position in relation to the triggering event is displayed and it is also possible to bookmark the data rows.

To change the displayed portion of the data area, move the slider of the vertical scroll bar on the right. To change the displayed portion of the nets, use the horizontal scroll bar under the screen.

The rows 1, 2 and columns 1, 2 contain data cell description. In the first row the names of the nets are displayed. If the net type is bus, double-clicking will decompose it into individual signals. If the chosen net is an individual signal of a decomposed bus, double-clicking its name will recompose the bus display. The [names](#) are displayed according to the settings of the [state analysis screen pop-up menu](#).

The second row shows the triggering word of each net. (See [Chapter 3.5.3](#))

The position of the row in relation to the triggering event is displayed in hexadecimal notation in the first column. To jump to a desired position use the item “Jump to base” of the [state analysis screen pop-up menu](#).

In the second column special properties of the row are specified. Possible values are T, 0, 1 ... 9. Value T signifies that in the row a triggering event occurred. This row is displayed in brown color. Values from 0 to 9 signify that the row was bookmarked under the number shown. Such row is displayed in green color.

When selected by left-clicking, the row is displayed in blue color.

3.5.1. State Analysis Screen Pop-up Menu

To open the state analysis screen pop-up menu, right-click the data cell on the screen.

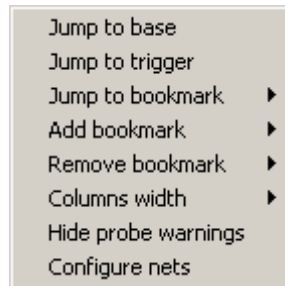

Fig. 3.5.1.1: State Analysis Screen Pop-up Menu

Following are the functions of the menu items:

“Jump to base” – Opens a window to enter the desired position to be displayed. Enter the value into the dialog box “Base” in hexadecimal notation and confirm clicking the OK. The specified row will be displayed as first.

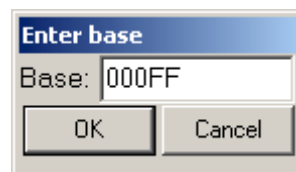

Fig. 3.5.1.2: Jump to base window

“Jump to trigger” – Displays data following the trigger event.

“Hide probe warnings” – In case some of the signal data was obtained from an input with no probe connected a warning is shown over the net display. To remove the warning, click this item. After running a new data gathering this message will appear again.

“Configure nets” – Opens net configuration window (See [Chapter 4.1.2](#))

The menu item “Jump to bookmark” opens a submenu.

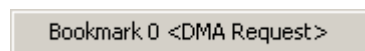

Fig. 3.5.1.3: Jump to bookmark submenu

This submenu contains the created bookmarks. To display the bookmarked row in the first position on the screen, click the bookmark.

Also the menu item “Add bookmark” opens a submenu.

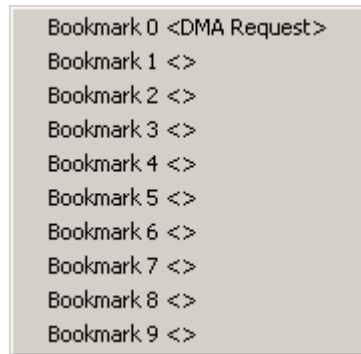

Fig. 3.5.1.4: Add bookmark submenu

Click any of the ten bookmarks to assign the bookmark to the row from which the pop-up menu was opened. Insert the name of the bookmark into a dialog box which will appear and confirm it by clicking the “OK” button.



Fig. 3.5.1.5: Bookmark name dialog box

The item “Remove bookmark” of the bookmark pop-up menu opens a submenu.

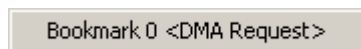

Fig. 3.5.1.6: Remove bookmark submenu

To remove a bookmark, click the item in this submenu.

Also the bookmark menu item “Column Width” opens a submenu.

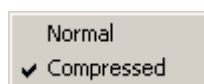

Fig. 3.5.1.7: Column width submenu

The submenu consists of the following two items:

“Normal” – The width of the column will be normal

“Compressed” – The width of the column will be as diminished as possible.

The choice of the column width also affects the name display (See [Chapter 3.5.2](#)).

3.5.2. Name Display

Setting the column width does not affect the display of bus name. The name of the bus will be shown and next to it also the size of the bus in square brackets (e.g. “0:5” bus consists of 6 signals).

If the column width is set to “Normal” the signal type net name will be displayed in the following way:

1. Name of the net
2. If the net belongs to a bus, also the bus name and the net's position in the bus (in square brackets, counting from 0) will be shown.

If the column width is “Compressed” the signal type net name will be displayed in the following way:

1. Name of the net
2. If the net belongs to a bus, also the initial character of the bus name and the net's position in the bus (in square brackets, counting from 0) will be shown.

3.5.3. Setting the trigger word

In the second row of the table on the screen a trigger words of all the nets are displayed.



Fig. 3.5.3.1: Trigger words shown on the state analysis screen

The process of setting the net's trigger word is the same as on the time analysis screen (See [Chapter 3.4.5](#))

4. Analyzer Controls

This chapter describes the Analyzer controls.

4.1. Main Menu

The main menu consists of the following items:

File / Load data – Loads the measured data (See [Chapter 4.1.1.](#))

File / Save data – Saves the measured data (See [Chapter 4.1.1.](#))

File / Export / Export to ASCII – Saves measured data in the ASCII mode

File / Print – Opens the print manager window (See [Chapter 4.5.](#))

File / Exit – Terminates the program

Settings | Configure nets – Opens the Net Configuration dialog window
(See [Chapter 4.1.2.](#))

Settings | Comm settings – Opens the Communication Settings dialog window
(See [Chapter 4.1.3.](#))

Settings | Tool tip help – Turns on/off the “Tool tip” help.

Help / Help – Opens help

Help / View readme – Opens readme file

Help / Enabled features – Displays information about enabled features

Help / About – Displays information about product

4.1.1. Saving and Loading the data

It is possible to save the measured data in two file formats: “M611 Data File” and “Compressed M611 Data File”. You can choose the file type in the Save As dialog window together with the file name. The first format does not employ any compression method and the maximal file size is approx. 2MB. The second format does use compression and the typical data file size is 300kB.

TIP: Compressed data file format is convenient for transferring the files on a floppy-disk or via e-mail.

4.1.2. Net Configuration

Main menu item *Settings / Configure nets* opens the net configuration window.

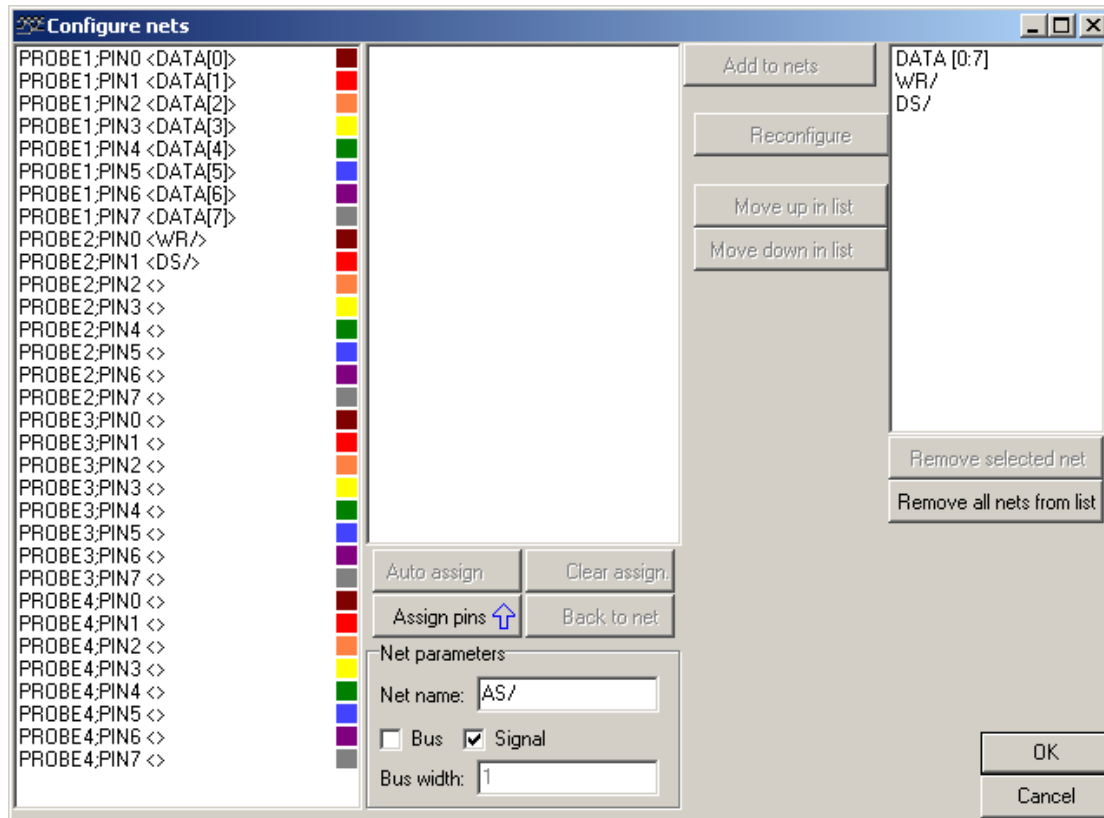

Fig. 4.1.2.1: Configure nets window

Definition of a new net consists of two steps. Firstly, insert the name of the net into the “Net name” box. Then choose a net type – create a new bus-type net clicking the “Bus” button or create a new signal-type net clicking the “Signal” button. If the type of the new net is bus, it is necessary to insert the size of the bus into the “Bus width” box. To finish the first step, click the “Assign pins” button.

In the second step it is necessary to assign the physical signals on the analyzer inputs to the net. The list in the middle of the window contains all the signals of the given net. There are two ways how to assign physical signal to the net signal: automatic or manual.

To assign the signals drag the physical signal onto the net signal. It is also possible to drag the net signal onto the physical signal.

To let the signals be assigned automatically, click the “Auto assign” button.

If none of the signals is assigned, the assignment follows these rules:

If the net is a bus with size 8, the program will assign (if possible) net signals to the signals coming from a probe to which no signal is assigned yet. In other case the program will assign the net signals to some of physical signals not occupied.

If some of the net signals are assigned already, the assignment rule is following:

The remaining signals are assigned (if possible) to consecutive physical signals.

To cancel all the assignments of net signals to physical signals, click the “Clear assign” button. To return to the net name configuration, click the “Back to net”

button. To add the net to the net list (in the upper right corner of the window), click the “Add to nets” button.

4.1.3. Communication Settings

Main menu item *Settings / Comm settings* opens the communication configuration window.

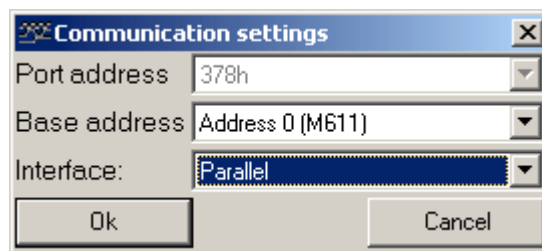

Fig. 4.1.3.1: Communication settings window

If the program is running under Win9x operating system, it is possible to set the address of the parallel port in the “Port address” combo box. However, for most computers it is not necessary to change this setting.

The base address of the device can be set in the “base address” combo box. If there is a code of a device shown in brackets after the address in the combo box, it means that such a device was detected on that particular base address.

The “Interface” combo box allows the user to choose the interface that the software uses to communicate with the device. USB interface can be used only with the EC602 adapter.

TIP: If the software does not detect the device at startup, it is possible to run automatic detection of the device from the dialog window that will open.

4.2. Setting the analyzer time base

The Time base panel is found in the main window.

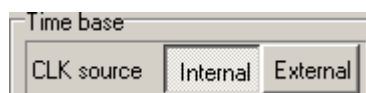

Fig. 4.2.1: Clock source settings

The setting options depend on the clocking source.

To select the internal source of clocking impulses, click the “Internal” button (See [Chapter 4.2.1](#)). This will switch the mode to time analysis.

To select the external source of clocking impulses, click the “External” button (See [Chapter 4.2.2](#)). This will switch the mode to state analysis.

4.2.1. Internal clocking source

If the internal clocking source is activated, the samples are taken in certain intervals (sample period).

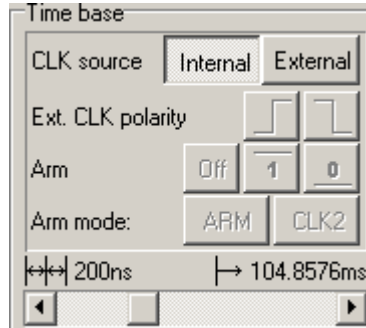

Fig. 4.2.1.1: Time base with internal clocking source

The sample period can be changed using the slider of the horizontal scroll bar in the bottom part of the panel. The values shown beyond the scroll bar specify:

- The sample period

- The length of period of measurement from the occurrence of the triggering event.

4.2.2. External clocking source

If the external clocking source is activated, the samples are taken at the leading/trailing edge of the external clock (connected to the 7th bit of the probe no.4), in case the so-called “arm” condition is fulfilled (the arm signal is connected to the 6th bit of the probe no.4).

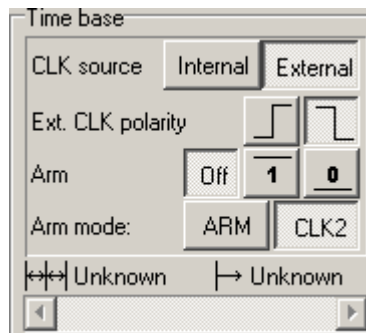

Fig. 4.2.2.1: Time base with the external source of the clocking impulses

Clicking the button:



- Activates the sensitivity to the leading edge of the clocking impulses.



- Activates the sensitivity to the trailing edge of the clocking impulses.

The type of the “Arm” condition can be set clicking one of the Arm mode buttons. The “ARM” button activates “arm” mode and the “CLK2” button activates “clk2” mode.

If you click the “Off” button, the “arm” condition will not be applied.

If you select the “1” button, the system will behave in the following way:

In the “arm” mode the sample will be taken only if the arm signal equals 1.

In the “clk2” mode the clock signal will be multiplied by the arm signal.

If you select the “0” button, the system will behave in the following way:

In the “arm” mode the sample will be taken only if the arm signal equals 0.

In the “clk2” mode the clock signal will be multiplied by the negation of the arm signal.

4.3. Trigger control panel

The triggering system control panel is located in the main window.

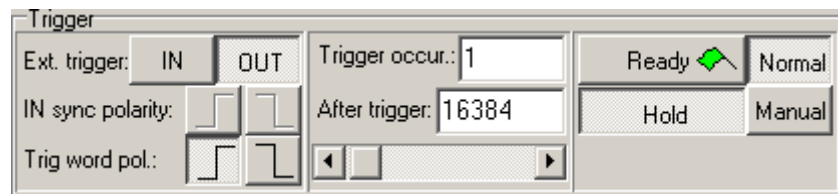

Fig. 4.3.1: Trigger controls

The trigger panel consists of two main parts: trigger controls (See [Chapter 4.3.1](#)) and measurement cycle controls (See [Chapter 4.3.2](#)).

4.3.1. Trigger controls

The trigger control elements determine the trigger source, the number of trigger event occurrences and the number of samples taken after the trigger event.



Fig. 4.3.1.1: The part of the Trigger panel with trigger controls

To set triggering source to external, click the “IN” button.

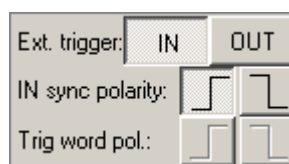

Fig. 4.3.1.2: External trigger source

By clicking the “IN sync polarity” buttons you can change the edge sensitivity in the following way:



- The trigger event is the leading edge



- The trigger event is the closing edge

To set the triggering source to internal, click the “OUT” button.

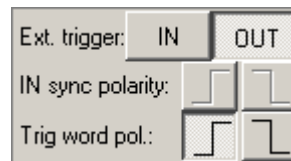

Fig. 4.3.1.3: Internal trigger source

Clicking the “Trig word polarity” buttons you can change the trigger event settings in the following way:



- The occurrence of the trigger word is the trigger event



- The cessation of the trigger word is the trigger event

The trigger word can be specified in the [time](#) / [state](#) analysis box depending on the chosen time base mode.

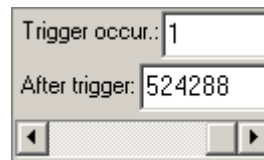

Fig. 4.3.1.4: Trigger and sample gathering settings control

The value in the “Trigger occur.” box specifies the number of trigger events that have to occur to run the data gathering.

The number of samples taken after the trigger event can be any number between 8 and 524288 divisible by 8. There are two ways to change it:

- Enter the value into the “After trigger” box.
- Set the value using the slider of the scroll bar under the “After trigger” box.

4.3.2. Measurement cycle controls

The Measurement cycle control elements determine the behavior of the analyzer before and after the data gathering.







Fig. 4.3.2.1: Measurement cycle controls

The analyzer can operate in the so-called “Manual” mode, where it does not wait for the trigger event. To switch to this mode, click the “Manual” button. To end this mode, click the „Normal“ button.

If the “Hold” button is switched on, the analyzer collects the data only once. If it is not, the analyzer collects the data cyclically.

To run the data gathering, click the “Ready” button.

During the data gathering the flag on the “Ready” button changes its color. This indicates the current phase of the process.

-  - The trigger event has not occurred yet
-  - The trigger event has already occurred; the data gathering is in progress
-  - The data is being transferred from the device into the computer
-  - The data gathering is finished

TIP: To cancel the data gathering, click on the flag.

4.4. Probe settings controls

In the bottom part of the main window the probe settings controls are located.

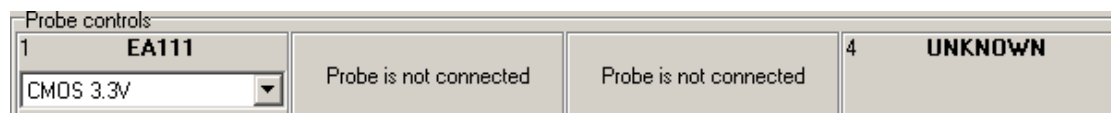

Fig. 4.1.1: Probe settings controls

It is possible to control each probe individually.

If the probe is not connected, “Probe is not connected” message is displayed.

If an unknown probe is connected, “UNKNOWN” message is displayed. If this happens, please download the most recent version of the software from our website <http://www.etcsk.com/>. In case the problem should persist, please contact us. If EA111 probe is connected, control elements described in the following chapter ([Chapter 4.4.1](#)) are displayed.

The controls described in [chapter 4.4.1](#). are activated if the probe EA111 is connected.

The controls described in [chapter 4.4.2](#). are activated if the probe EA112 is connected.

The controls described in [chapter 4.4.3](#). are activated if the probe EA113 is connected.

TIP: Controls for each probe contain number of connector used for probe connection. The window with information about probe is displayed after click on this number.

4.4.1. EA111 probe controls

If EA111 probe is connected, in the corresponding panel the probe control elements are displayed.



Fig. 4.4.1.1.: EA111 probe controls

In the upper-left corner the number of the connector to which the probe is connected is shown. The combo box lets you to select the probe's threshold voltage.

4.4.2. EA112 probe controls

If EA112 probe is connected, in the corresponding panel the probe control elements are displayed.

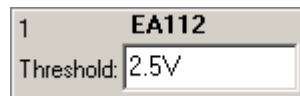

Fig. 4.4.2.1.: EA112 probe controls

In the upper-left corner the number of the connector to which the probe is connected is displayed.

It is possible to enter threshold voltage to „Threshold“ edit box. If the value is in range from -10 to 10 , the values is considered as volts. Otherwise, value is considered as milivolts.

4.4.3. EA113 probe controls

If EA113 probe is connected, in the corresponding panel the probe control elements are displayed.

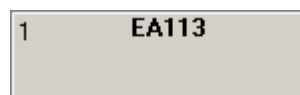

Fig. 4.4.3.1.: EA113 probe controls

In the upper-left corner the number of the connector to which the probe is connected is displayed.

4.5. Print Support

To open the print manager window, click the “Print” item of the [main menu](#).

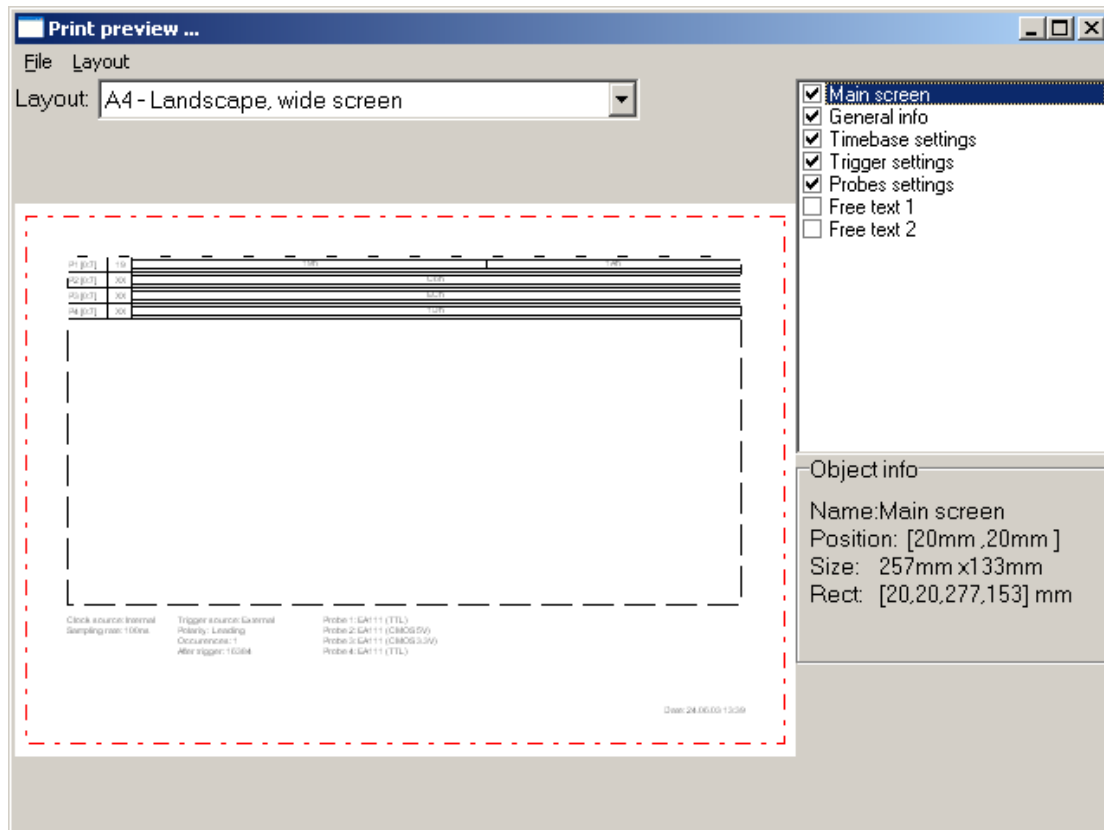

Fig. 4.5.1: Print Manager Window

On the left side of the window the page is previewed as it will be printed. Several important parts of the page are highlighted. The lines marking these parts will not be printed. The red line outlines the printable area of the page. Selected object is marked by black dashed outline.

To select an object, click it. You can move it into a desired position by dragging it. To change the size of a chosen object, drag its outline.

In the lower right corner of the window the following information on the properties of the selected object is shown:

- “Name” – Name of the object
- “Position” – Coordinates of the upper-left corner of the object on the page in millimeters
- “Size” – Size of the object in millimeters
- “Rect” – Position of the upper-left corner and the lower-right corner on the page in millimeters

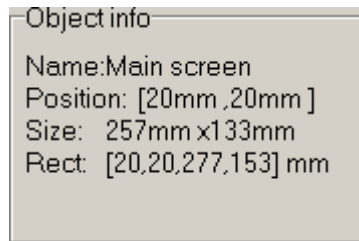

Fig. 4.5.2: Object Info

In the upper-right corner of the window names of all the objects that can be placed into the page are listed. To display/hide an object, click the box next to the object name. To select an object, click the name of the object (if the object is displayed).

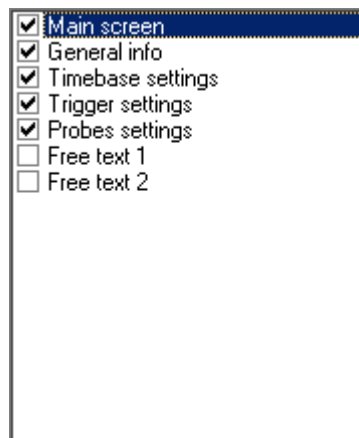

Fig. 4.5.3: List of available objects

TIP: Two objects with content that can be specified by the user are available (objects “Free text 1” and “Free text 2”). Double-clicking any of these objects opens a dialog window to insert the text to be displayed.

It is possible to select automatic layout and predefined schemes of object display in the “Layout” combo-box. Choosing the “Custom” item does not affect the current layout.

WARNING: In the “Layout” combo-box only the layouts available for the current paper size are shown.

It is possible to save a modified layout under the current name choosing the “Layout / Save layout” item of the main menu of this window. To save it under a different name, choose “Layout / Save layout as”. A dialog box will appear to insert the name for the new layout ([Chapter 4.5.1](#)).

Following are the other items Layout menu consists of:

„Layout / Manage layouts” – Opens the Layout manager window (See [Chapter 4.5.2](#)).

„File / Printer setup“ – Opens the printer settings window

„File / Print“ – Prints the page

„File / Close“ – Terminates the print manager

4.5.1. Setting the name of a new layout

To open the Specify layout name dialog window, select the “*Layout / Save layout as*” item. Now you can enter the name of the new scheme.

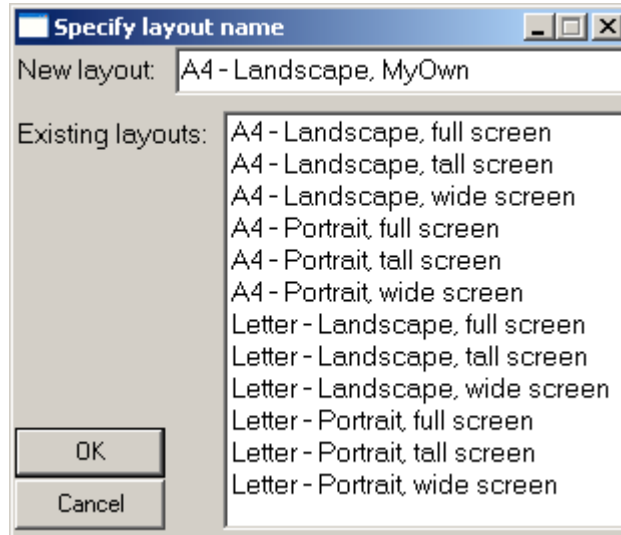

Fig. 4.5.1.1: Specify Layout Name Window

It is necessary to insert a name of the new layout into the “New layout” box. This name has to differ from the names of the existing layouts. If the name would be identical with the name of another layout, this layout would be replaced by the new layout. At the same time the existing layout would be highlighted in the layout list. If you click a name of a layout in the list, this name will appear in the “New layout” box.

To save the layout, click the OK button.

4.5.2. Layout Manager

To open the Layout Manager window, select the “*Layout / Manage layouts*” item in the main menu of the print manager window.

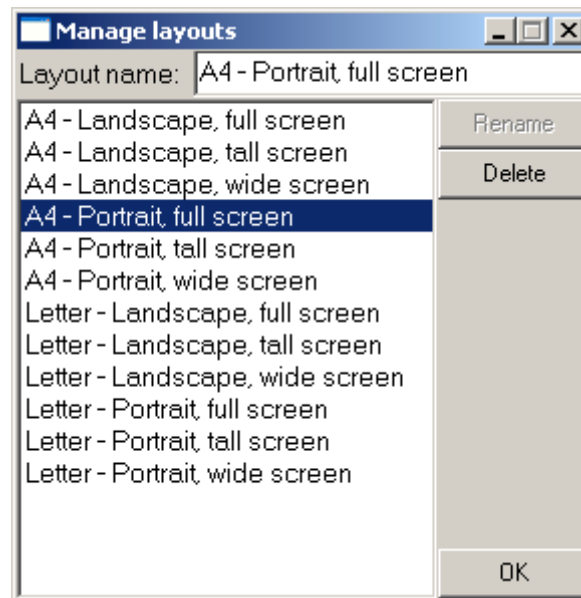

Fig. 4.5.2.1: Layout Manager Window

To select a layout, double-click its name in the list.

To erase the selected layout, click the “Delete” button.

To rename a layout, select it, insert the new name into the “Layout name” box and then click the “Rename” button.

5. Technical Specifications

This chapter describes the technical specifications of the M611 Logic Analyzer and the EA111, EA112 and EA113 Probes.

5.1. M611 Analyzer Technical Specifications

5.1.1. Timing Analysis

Number of channels	32
Clock frequency	2.5kHz – 100MHz
Triggering	Internal, external
Width of the trigger word	32 bit
Trigger word's bit setting	1, 0, X
External triggering	1 bit – leading or trailing edge
Trigger event occurrence to trigger	1 to 65535
Record length	Max. 524 280 words
Position of the trigger word in the record	Anywhere, with step of 8 words
Data acquisition mode	single, repeated

Table 5.1.1.1. – M611 analyzer technical specifications in timing analysis mode

5.1.2. State Analysis

Channels	30
External clock inputs	1
Clock arm	1
Clock frequency	DC - 50 MHz
Width of the trigger word	30 bit
Trigger word's bit setting	1, 0, X
External triggering	1 bit – leading or trailing edge
Record length	Max. 524 280 words
Position of the trigger word in the record	Anywhere, with step of 8 words

Table 5.1.2.1. – M611 analyzer technical specifications in state analysis mode

5.2. EA111 Probe Technical Specifications

Number of channels	8
Delay	< 10 ns
Skew between the channels	< 1 ns
Threshold voltage	3.3V CMOS, 5V CMOS, TTL
*Input voltage range in 3.3V CMOS mode	From -2V to +5.5V
*Input voltage range in 5V CMOS mode	From -2V to +7V
*Input voltage range in the TTL mode	From -2V to +7V

* - Stress out of the range may cause permanent damage to the device.

Table 5.2.1. – EA111 technical specifications

5.3. EA112 Probe Technical Specifications

Number of channels	8
*Delay	<35ns if $0.25V < U_i - U_T < 2V$ <40ns if $2V < U_i - U_T < 5V$ <60ns if $5V < U_i - U_T < 10V$ <120ns if $10V < U_i - U_T < 15V$
Threshold voltage	-5V to +5V in < 40mV steps
Threshold voltage setting error	+100mV +-2% of the value set
**Max input voltage range	+15V

* - U_i is the input voltage before the transition and U_T is the threshold voltage

** - Stress out of the range may cause permanent damage to the device.

Table 5.3.1. – EA112 technical specifications

5.4. EA113 Probe Technical Specifications

Number of channels	8 diferential
*Delay	<35ns if $0.25V < U_D < 2V$ <40ns if $2V < U_D < 5V$ <60ns if $5V < U_D < 10V$ <120ns if $10V < U_D < 15V$
**Max differential input voltage range	+20V
**Max common input voltage range	+15V

* - U_D is the diferential voltage before transition

** - Stress out of the range may cause permanent damage to the device

Table 5.4.1. – EA113 technical specifications

6. Programmer's information

6.1. .dw format description

The M611 analyzer software uses binary format .dw to save acquired data. This chapter describes not compressed version of .dw format.

6.1.1. Data structures

.dw contains following data structures:

Structure name	Size	Structure description	C++
Integer	4 bytes	32 bit signed integer	int
Cardinal	4 bytes	32 bit unsigned integer	unsigned int
Boolean	1 byte	8 bit, where 0 = false a 1 = true	bool
Real	8 bytes	floating point value	float
Double	8 bytes	floating point value	float
String	variable	This structure starts with Integer=number of string characters. It is followed by 8bit characters.	-
Signature	12 bytes	This structure contains three Integer structures in this order (Product ID, which created file; File ID; File Version)	-

Table 6.1.1.2. – Format .dw data structures

6.1.2. Description

Data are saved in following order:

Data name	Data structure	Data description	Version
MainSignature	Signature	.dw format has Product ID=611; File ID=0. Version contains information about file version. Odd number indicates compressed format.	All
DataSize	Integer	Amount of acquired data	All
TimeBase	Integer	Time base index (see 6.1.3.)	All
AfterTrigger	Integer	Amount of data acquired after trigger	All
DataOffset	Integer	Internal data of SW	All
BottomBound	Integer	Internal data of SW	All
ExternalClocking	Boolean	Indicates clocking from external source	All
CLKLeading	Boolean	Indicates sensitivity to leading edge of external clock	>= 4
ARMCLK	Boolean	Indicates ARM in CLK2 mode	>= 4
ARM	Integer	0 – sensitive to zero; 1 – sensitive to one; 2 – off	>= 4
Probe1	Real	Probe 1 reference voltage (see 6.1.4.)	>= 4

Probe2	Real	Probe 2 reference voltage (see 6.1.4.)	>= 4
Probe3	Real	Probe 3 reference voltage (see 6.1.4.)	>= 4
Probe4	Real	Probe 4 reference voltage (see 6.1.4.)	>= 4
TriggerOccurrences	Integer	Amount of trigger occurrences	>= 4
ExtTrigger	Boolean	Indicates triggering from external source	>= 4
SyncLeading	Boolean	Indicates triggering on leading edge of external signal	>= 4
TrigWordLeading	Boolean	Indicates triggering on rise of trigger word	>= 4
AcquisitionDate	Double	Acquisition date	>= 4
NetSignature	Signature	Net signature: Product ID=611; File ID=1; Version=1	All
<i>Block 1 start</i>			All
NetLength	Integer	Amount of configured elements	
<i>Block 2 start</i>			
NetName	String	Net name	
ExplosionGroup	Integer	Internal data of SW	
SignalCount	Integer	Amount of signals, which belongs to net	
<i>Block 3 start</i>			
Mask	Cardinal	Signal mask (signal bit is masked using logical and)	
ShiftLeft	Integer	Shift left, which moves signal bit to proper position in net	
ShiftRight	Integer	Shift right, which moves signal bit to proper position in net	
<i>Block 3 end</i>		Block 3 is repeated SignalCount times	
<i>Block 2 end</i>		Block 2 is repeated NetLength times	
<i>Block 1 end</i>		Block 1 is repeated twice, where first occurrence contains information about displayed nets.	
PCode1	Integer	Probe 1 code (see 6.1.5.)	All
PCode2	Integer	Probe 2 code (see 6.1.5.)	All
PCode3	Integer	Probe 3 code (see 6.1.5.)	All
PCode4	Integer	Probe 4 code (see 6.1.5.)	All
AutoTrigger	Boolean	Indicates triggering in auto mode	All
Hold	Boolean	Indicates „hold“ state of SW	All
<i>Block 1 start</i>			All
Data	Cardinal	Data on the position. Valid data are aligned to the end of the block.	
<i>Block 1 end</i>		Block 1 is repeated 524288 times.	

6.1.3. Time base codes

Index	Sampling period	Sampling rate
1	10ns	100MS/s
2	20ns	50MS/s

3	40ns	25MS/s
4	100ns	10MS/s
5	200ns	5MS/s
6	400ns	2.5MS/s
7	1us	1MS/s
8	2us	500kS/s
9	4us	250kS/s
10	10us	100kS/s
11	20us	50kS/s
12	40us	25kS/s
13	100us	10kS/s
14	200us	5kS/s
15	400us	2.5kS/s

Table 6.1.3.1. – Time base codes

6.1.4. Probe reference voltages

The influence of internal reference on threshold voltage depends on the type of the probe:

Probe	Reference voltage	Threshold
EA111	0 V	CMOS 3.3V
EA111	1.25 V	CMOS 5V
EA111	2.5 V	TTL
EA112	x V	$4*(x-1.25)$ V
EA113	x V	No influence

Table 6.1.4.1. – Probe reference voltages

6.1.5. Probe codes

Probe code	Probe
1	EA111
2	EA112
3	EA113
15	No probe connected

Table 6.1.5.1. – Probe codes